



## Q4 SERIES 4 WATT HIGH PRECISION REGULATED HV DC/DC CONVERTERS



## FEATURES

- ▶ **Customer Selects Output Voltage**
- ▶ Fully Regulated Outputs to 5000 Vdc
- ▶ 0-100% Programmable + or - Output
- ▶ High Stability (<0.005%/°C)
- ▶ Line / Load Regulation < 0.001%
- ▶ Ultra Low Output Noise & EMI/RFI
- ▶ Onboard Reference & Output Monitor
- ▶ Continuous Short Circuit Protection

The Q4 Series high voltage DC/DC converter offers a 100% programmable high voltage output using a 0 to 9Vdc analog signal. Their exceptionally low noise, regulation, and stability make them ideally suited for applications including: Photomultiplier tubes, MASS Spectrometers, Radiation Counters and Ultrasonic Transducers

## ELECTRICAL SPECIFICATIONS

Input Voltage Range .....	24V to 30Vdc	Input Filter .....	Low ESR Capacitor
Output Voltage Accuracy .....	< 1%	Reverse Input Protection .....	50Vdc
Line Regulation .....	<0.001%	Efficiency .....	> 50%
Load Regulation .....	<0.001%	Short Circuit Protection .....	Continuous
Output Ripple .....	See Table	Switching Frequency .....	150 - 250 kHz
Onboard Precision Reference .....	9Vdc @ 10mA	Programming Voltage Shutdown .....	> 9.2Vdc
Programming Voltage .....	0 to +9Vdc @ <100uA	Response Time .....	<500 ms (Full Load, full scale response)
Programming Linearity .....	<1%	Output Voltage Monitor .....	<1%

## GENERAL SPECIFICATIONS

Stability .....	< 0.005% / Hr.	Thermal Shock Limit .....	1°C / 10 Seconds
Temp. Stability .....	+/- 0.005%/°C	EMI/RFI .....	Six Sided Shield
Temp. (Operating , Case) .....	0 to +50°C	Derating .....	None
Temp. (Storage) .....	-40 to +85°C	Cooling .....	Free-Air Convection
Humidity .....	20 to 85% (Non-Condensing)	Certifications .....	Designed to meet UL60950

## PHYSICAL SPECIFICATIONS

Dimensions & Weight .....	5.12 x 3.54 x 1.1 inches @ 5.4 Oz	Encapsulation Material .....	UL 94V-0 Epoxy
Dimensions & Weight .....	5.75 x 3.88 x 1.63 inches @ 6.2 Oz	Case Material .....	Coated Aluminum

**NOTE:** Specifications are at the maximum rated output after a 30 minute warm-up period unless otherwise specified.



## Q4 SERIES 4 WATT HIGH PRECISION REGULATED HV DC/DC CONVERTERS

### REPRESENTATIVE MODEL LISTING

MODEL NUMBER		OUTPUT SPECIFICATIONS					SWITCHING FREQUENCY
Non-RoHs	RoHs	VOLTAGE	RIPPLE	CURRENT	REGULATION		
					LOAD	LINE	
Q4-P50	Q4-P50/Y	0V to +500Vdc	<0.001% (5mV p-p)	0 - 8mA	<0.001%	<0.001%	250 kHz
Q4-N50	Q4-N50/Y	0V to -500Vdc	<0.001% (5mV p-p)	0 - 8mA	<0.001%	<0.001%	250 kHz
Q4-P100	Q4-P100/Y	0V to +1000Vdc	<0.0002% (2mV p-p)	0 - 4mA	<0.001%	<0.001%	250 kHz
Q4-N100	Q4-N100/Y	0V to -1000Vdc	<0.0002% (2mV p-p)	0 - 4mA	<0.001%	<0.001%	250 kHz
Q4-P150	Q4-P150/Y	0V to +1500Vdc	<0.0013% (2mV p-p)	0 - 2.6mA	<0.001%	<0.001%	250 kHz
Q4-N150	Q4-N150/Y	0V to -1500Vdc	<0.0013% (2mV p-p)	0 - 2.6mA	<0.001%	<0.001%	250 kHz
Q4-P200	Q4-P200/Y	0V to +2000Vdc	<0.0001% (2mV p-p)	0 - 2mA	<0.001%	<0.001%	250 kHz
Q4-N200	Q4-N200/Y	0V to -2000Vdc	<0.0001% (2mV p-p)	0 - 2mA	<0.001%	<0.001%	250 kHz
Q4-P300	Q4-P300/Y	0V to +3000Vdc	<0.0001% (3mV p-p)	0 - 1.3mA	<0.001%	<0.001%	200 kHz
Q4-N300	Q4-N300/Y	0V to -3000Vdc	<0.0001% (3mV p-p)	0 - 1.3mA	<0.001%	<0.001%	200 kHz
Q4-P500	Q4-P500/Y	0V to +5000Vdc	<0.0002% (10mV p-p)	0 - 0.8mA	<0.001%	<0.001%	200 kHz
Q4-N500	Q4-N500/Y	0V to -5000Vdc	<0.0002% (10mV p-p)	0 - 0.8mA	<0.001%	<0.001%	200 kHz

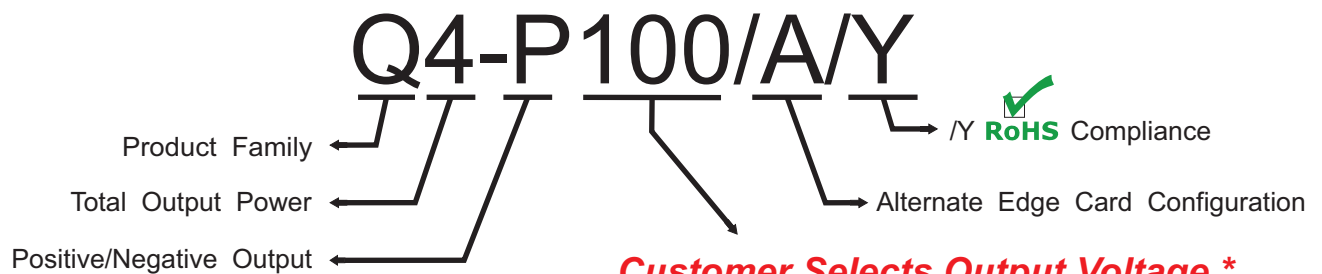

**Customer Selects Output Voltage \***

**\*ACTUAL OUTPUT VOLTAGE IS 10X**

The Q4 Series are designed such that the customer may order any output voltage (positive or negative) from 500Vdc to 5000Vdc at no additional charge.



## Q4 SERIES 4 WATT HIGH PRECISION REGULATED HV DC/DC CONVERTERS

### STANDARD CONFIGURATION

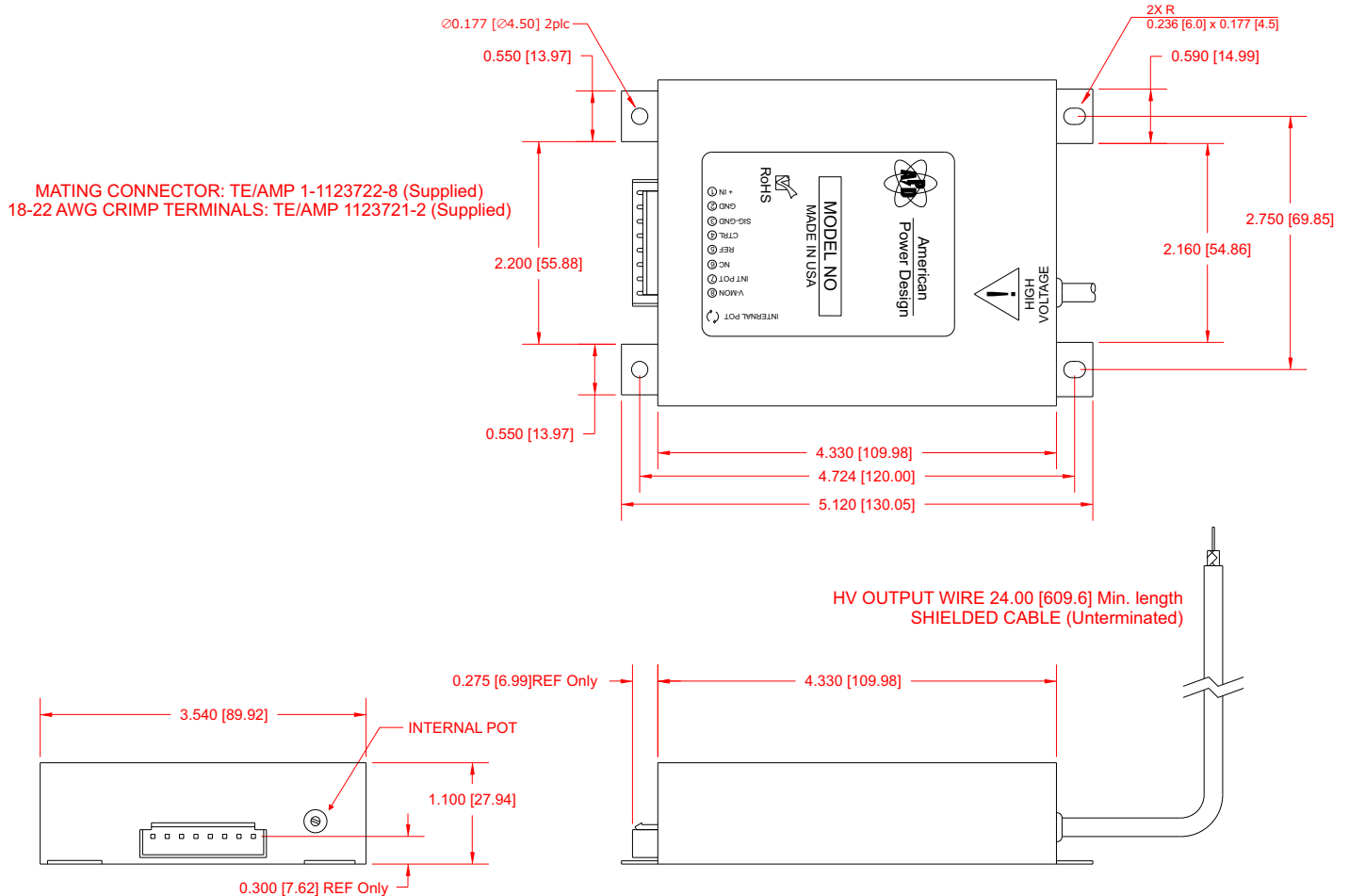

PIN #	FUNCTION	PIN #	FUNCTION
1	+ IN	5	V REFERENCE
2	GND	6	NC
3	SIG-GND	7	INTERNAL POT
4	CONTROL	8	V MONITOR

Dimensions are in Inches  
[Metric equivalents in brackets]



## Q4 SERIES 4 WATT HIGH PRECISION REGULATED HV DC/DC CONVERTERS

### ALTERNATE EDGE CARD CONFIGURATION /A

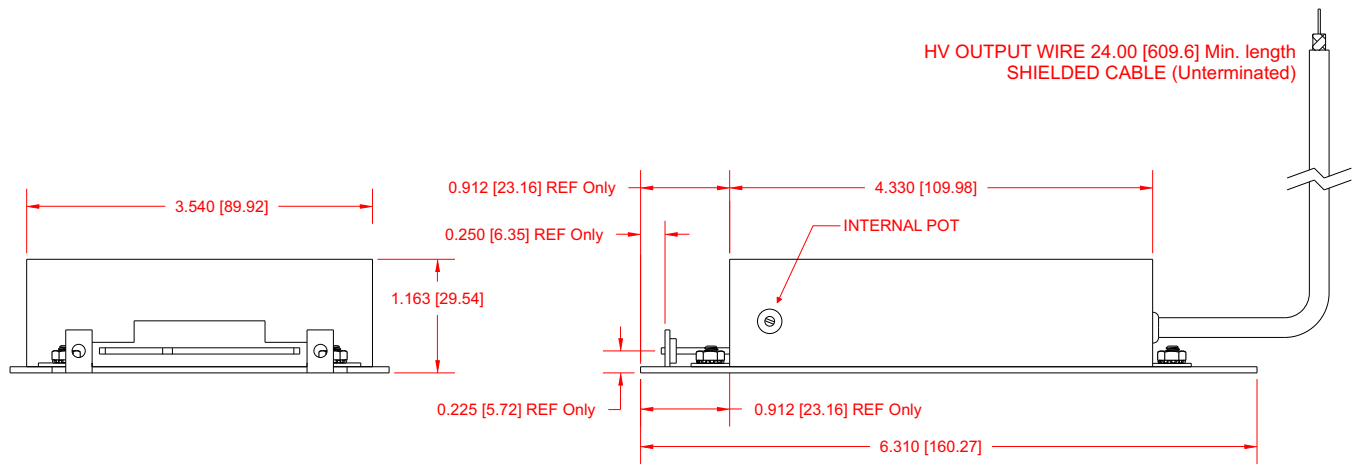
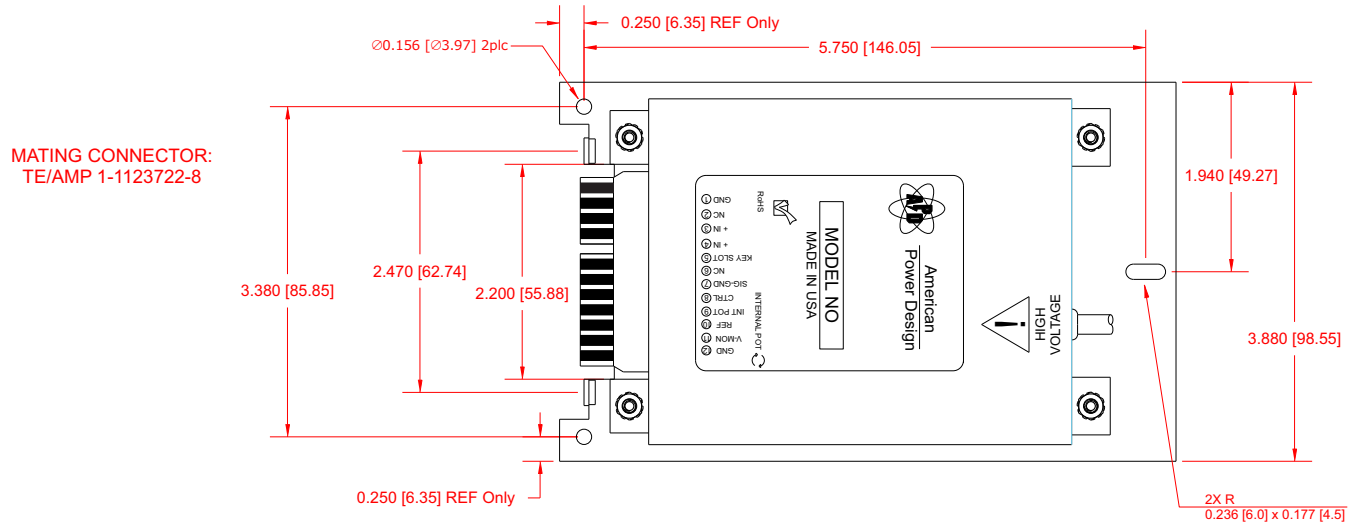

PIN #	FUNCTION	PIN #	FUNCTION
1	GND	7	SIG-GND
2	NC	8	CONTROL
3	+ IN	9	INTERNAL POT
4	+ IN	10	V REFERENCE
5	KEY SLOT	11	V MONITOR
6	NC	12	GND

*Dimensions are in Inches  
[Metric equivalents in brackets]*



## Q4 SERIES 4 WATT HIGH PRECISION REGULATED HV DC/DC CONVERTERS

### APPLICATION NOTES

#### INRUSH CURRENT

The inrush current of the Q4 Series has been kept as low as possible. However, a series resistor may be inserted in the input line to limit this current further.

#### REVERSE INPUT PROTECTION

The Q4 Series is equipped with a diode placed in series with the + Input of the converter. This allows current to flow only if the correct polarity is applied.

#### SHORT CIRCUIT PROTECTION

The Q4 Series is equipped with short circuit protection. The converter will fold-back the input power whenever a short circuit is applied to its output and automatically recover after the overload condition is removed.

#### OUTPUT VOLTAGE MONITOR

The Q4 is equipped with an output voltage monitor circuit. The voltage monitor is a precision resistor network that provides a low voltage output proportional to the converters output voltage.

The table below provides the voltage ratio and impedance for a given output voltage.

Output Voltage	Monitor Voltage	Impedance
0 to 500Vdc	0 to 5Vdc	50k
0 to 1000Vdc	0 to 1Vdc	10k
0 to 1500Vdc	0 to 1.5Vdc	25k
0 to 2000Vdc	0 to 2Vdc	25k
0 to 3000Vdc	0 to 3Vdc	30k
0 to 5000Vdc	0 to 5Vdc	100k

#### PROGRAMMING VOLTAGE

A 0V to +9V signal will program the power supply for 0 to 100% rated output voltage. The input impedance for this control pin is typically 100KΩ. If the programming signal exceeds 9.2Vdc the converter will shutdown and automatically recover when the programming signal returns to within normal operating range.

#### OUTPUT VOLTAGE TRACKING

The output voltage tracks the Control pin within 1% from 1% to 100% of output voltage.

Figure below show a typical plot of both the actual and calculated output voltage as a function of control voltage.

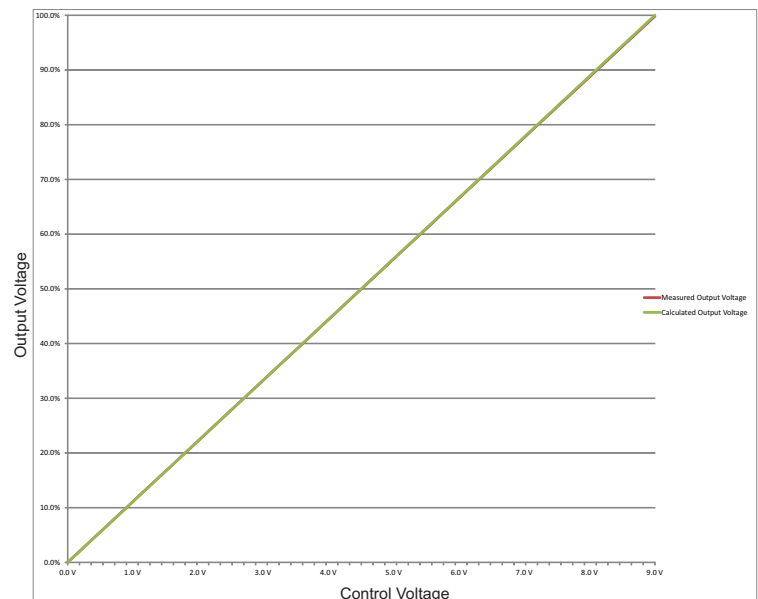

#### Operating Conditions:

Nominal Input Voltage = Fixed

Output Load = Resistive (fixed at full output current @ 100% output voltage)



## Q4 SERIES 4 WATT HIGH PRECISION REGULATED HV DC/DC CONVERTERS

### APPLICATION NOTES

#### INTERNAL POTENTIOMETER

The Q4 Series is equipped with a internal multi-turn potentiometer and can be utilized to control the output voltage.

Figures below shows the typical connections needed.

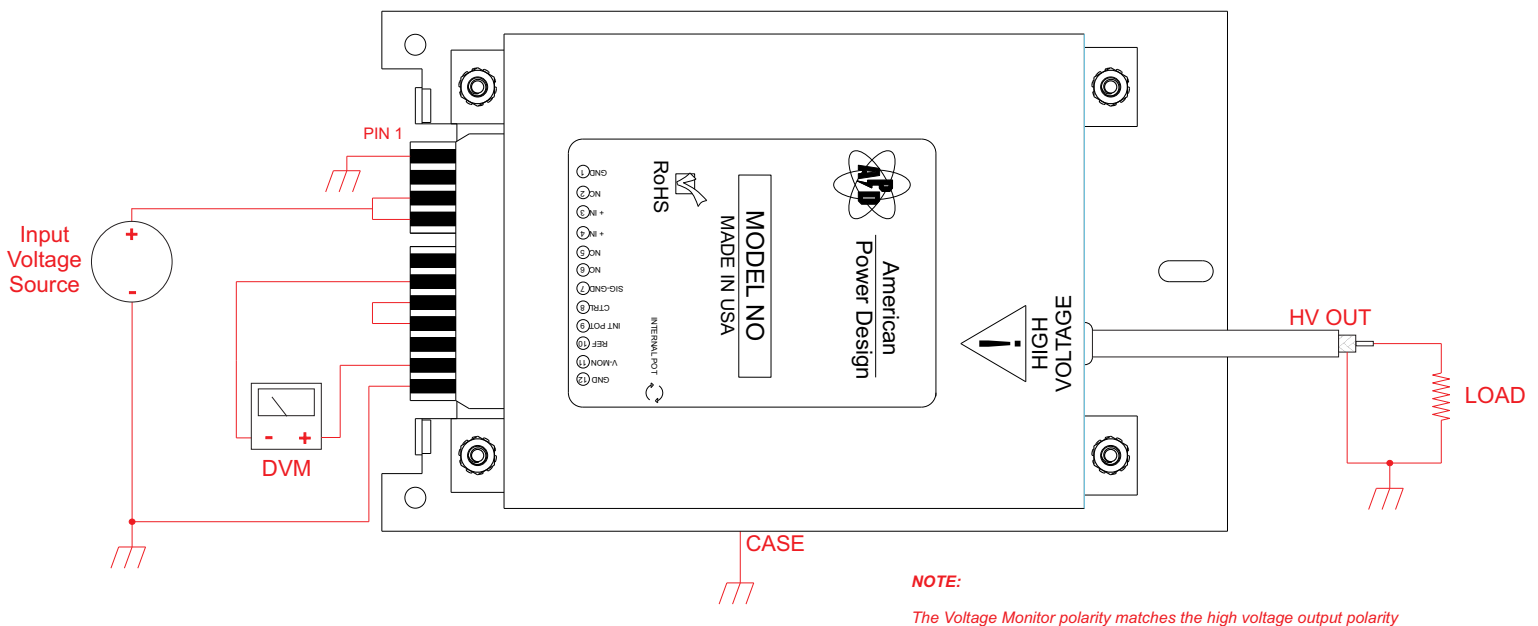
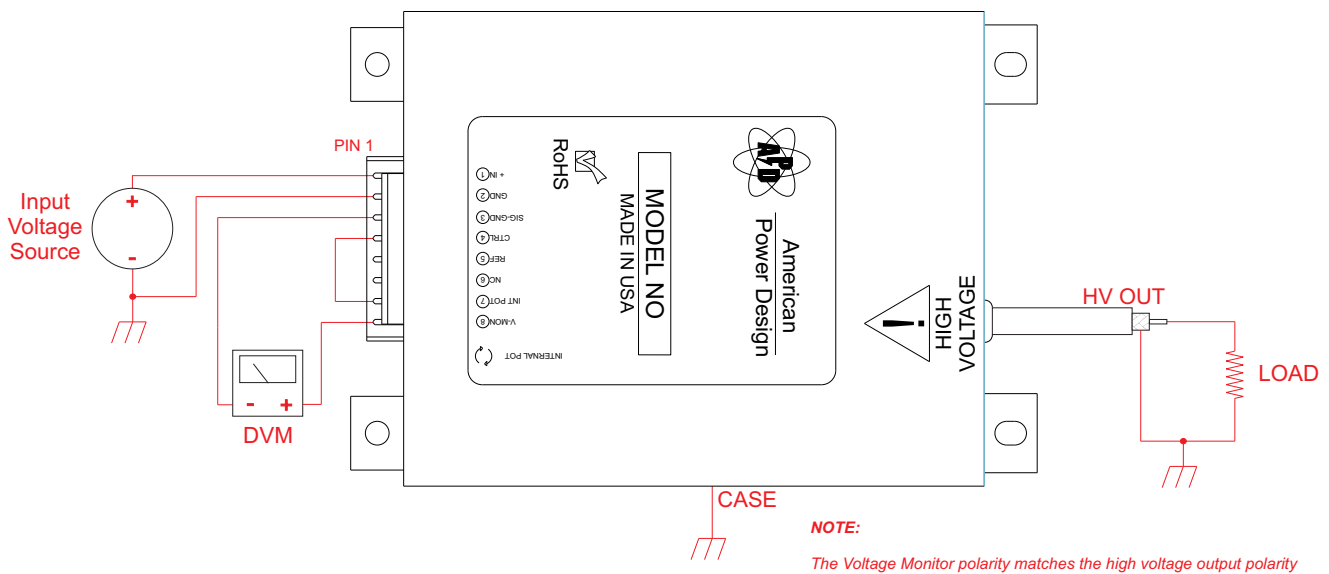



## Q4 SERIES 4 WATT HIGH PRECISION REGULATED HV DC/DC CONVERTERS

### APPLICATION NOTES

#### EXTERNAL / REMOTE POTENTIOMETER

The output voltage of the Q4 Series can be controlled with an external or remote potentiometer.

Figures below show the typical connections needed.

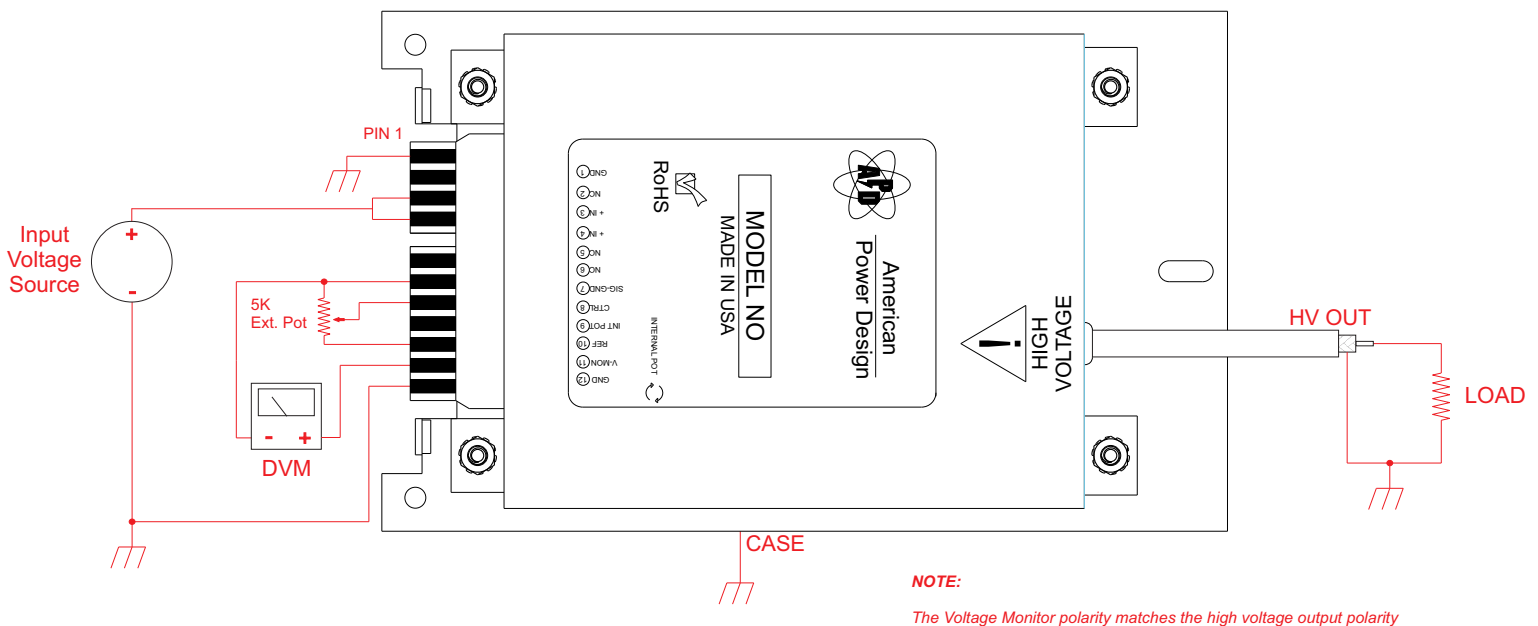
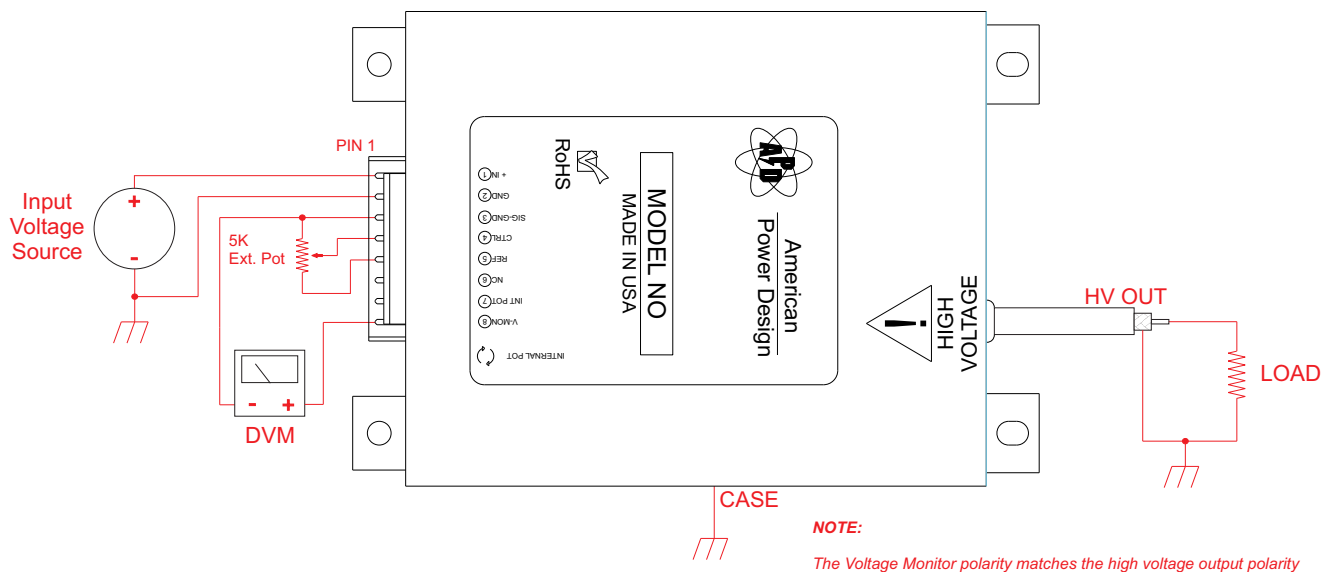



## Q4 SERIES 4 WATT HIGH PRECISION REGULATED HV DC/DC CONVERTERS

### APPLICATION NOTES

#### EXTERNAL / REMOTE VOLTAGE SOURCE

The output voltage of the Q4 Series can be controlled with an external or remote voltage source .

Figures below shows the typical connections needed.

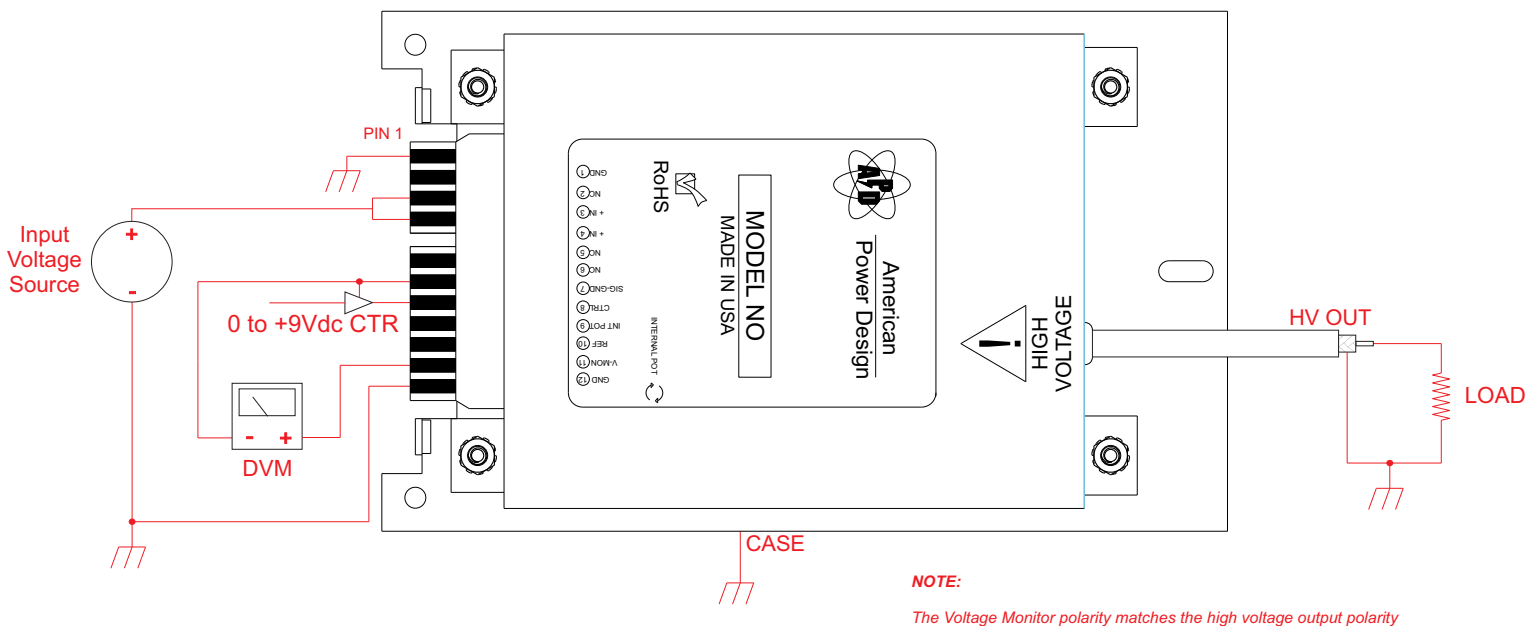
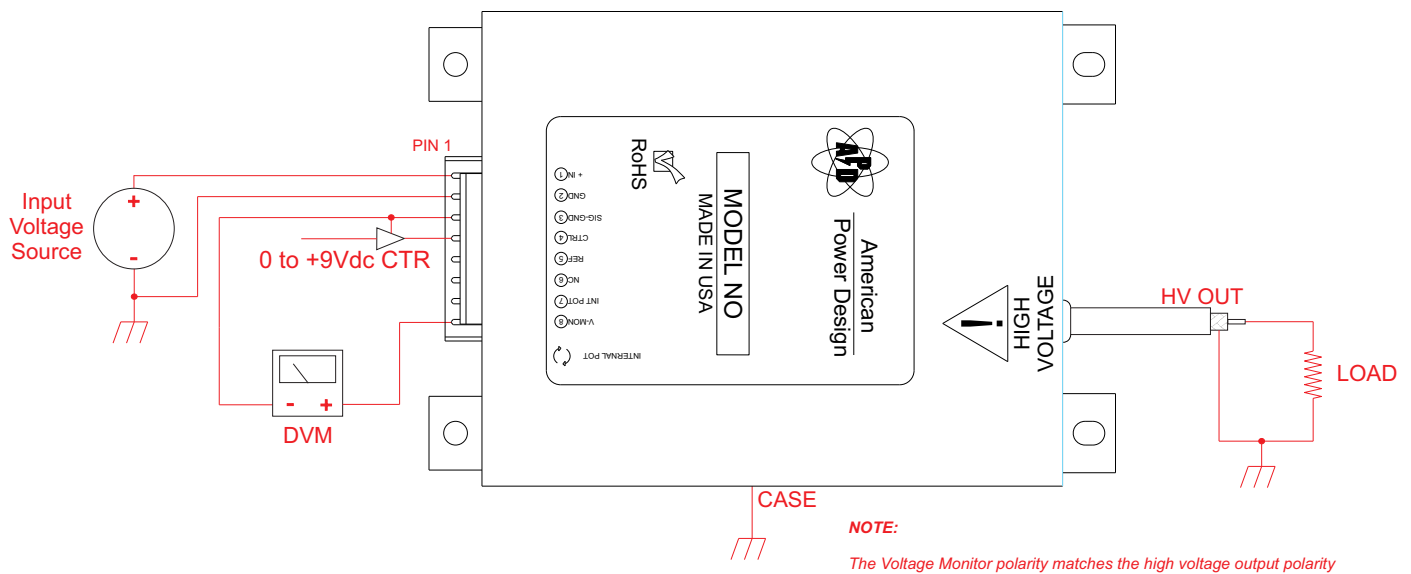





## Q4 SERIES 4 WATT HIGH PRECISION REGULATED HV DC/DC CONVERTERS

### APPLICATION NOTES

#### CLEANING AGENTS

In order to avoid possible damage, any penetration of cleaning fluids must be prevented, since the power supplies are not hermetically sealed.

#### NUCLEAR AND MEDICAL APPLICATIONS

American Power Design products are not designed, intended for use in, or authorized for use as critical components in life support systems, equipment used in hazardous environments, or nuclear control systems without the express written consent of American Power Design, Inc.

#### TECHNICAL REVISIONS

The appearance of products, including safety agency certifications pictured on labels, may change depending on the date manufactured. Specifications are subject to change without notice.

#### SAFETY REQUIREMENTS

The converters are designed to meet North American and International safety regulatory requirements per UL 60950-1/CSA 22.2 No. 60950-1-07 Second Edition, IEC 60950-1:2005, and EN 60950-1:2006. Basic Insulation is provided between input and output. To comply with safety agencies requirements, an input line fuse must be used external to the converter. The table below provides the recommended fuse rating for use with this family of products.

Input Voltage Range	Fuse Rating
24V - 30Vdc	1A

If one input fuse is used for a group of modules, the maximum fuse rating should not exceed 10A.

#### WARRANTY

All products manufactured by American Power Design, Inc. (APD) are warranted to be free of defects due to material or workmanship for a period of one year from date of shipment. At our option, APD will repair or replace any non-conforming product.

APD expressly disclaims any liability for consequential or incidental damages resulting from the use or misuse of its products by the purchaser or others.

This warranty is in lieu of all warranties expressed or implied, including the warranties of merchantability. No other warranties, obligations, or liabilities are expressed or implied.

All products being returned for repair require a return material authorization(RMA) assigned by APD prior to return shipment.