

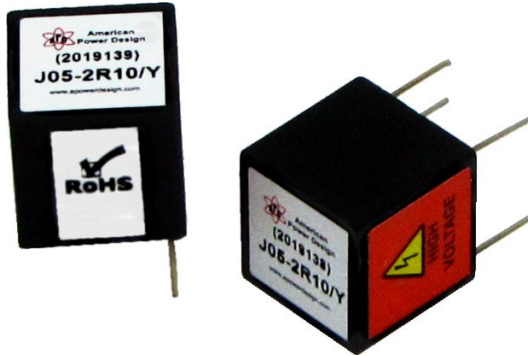

J05 SERIES 0.5 WATT PROPORTIONAL HV DC/DC CONVERTERS

FEATURES

- ▶ Customer Selects Output Voltage
- ▶ Ultra Miniature 0.125 Cubic Inches
- ▶ Single Outputs to + or - 2000 Vdc
- ▶ Dual Outputs to +/- 450 Vdc
- ▶ High Reliability
- ▶ Industry Standard Pinouts
- ▶ Temperature Range (-25 to +70°C)
- ▶ 400 kHz Switching Frequency
- ▶ Continuous Short Circuit Protection



The J05 Series of miniature DC/DC converters offers a 500 Vdc isolated high voltage output directly proportional to input voltage. They are available in industry standard pinouts and a optional shielded case. These miniature converters are ideal for applications requiring minimal size and weight. All models will tolerate a short circuit indefinitely.

ELECTRICAL SPECIFICATIONS

| | | | |
|------------------------|--------------|----------------------------------|-------------------|
| Voltage Accuracy | +/- 5% | Input Filter | Low ESR Capacitor |
| Line Regulation | Proportional | Efficiency | 60% (typ.) |
| Load Regulation | < 15% | Short Circuit Protection | Continuous |
| Output Ripple | < 0.1% P-P | Switching Frequency | 300 - 500kHz |
| Startup Voltage | < 0.7Vdc | Output Isolation | 500 Vdc |
| | | Input / Output Capacitance | < 30pF |

GENERAL SPECIFICATIONS

| | | | |
|--------------------------------|---------------------------|----------------|---|
| Temp. Stability | +/-0.05%/°C | EMI/RFI | Shielded Version Available (<i>Suffix /S</i>) |
| Temp. (Operating , Case) | -25 to +70°C | Derating | None |
| Temp. (Storage) | -50 to +105°C | Cooling | Free-Air Convection |
| Humidity | 0 to 95% (Non-Condensing) | | |

PHYSICAL SPECIFICATIONS

| | | | |
|------------------|------------------------|------------------------------|----------------|
| Dimensions | 0.5 x 0.5 x 0.5 inches | Encapsulation Material | UL 94V-0 Epoxy |
| Weight | 0.15 Oz | Case Material | Black Phenolic |



J05 SERIES 0.5 WATT PROPORTIONAL HV DC/DC CONVERTERS

5V INPUT SINGLE OUTPUTS

| REPRESENTATIVE MODEL LISTING | | | | | | | |
|------------------------------|-------------|----------------------|---------|-----------|-----------------------|------------|---------|
| MODEL NUMBER | | INPUT SPECIFICATIONS | | | OUTPUT SPECIFICATIONS | | |
| Non-RoHs | RoHs | VOLTAGE | NO LOAD | FULL LOAD | VOLTAGE | RIPPLE | CURRENT |
| J05-5R10 | J05-5R10/Y | 0V to 5Vdc | <100 mA | <250 mA | 0V to 100Vdc | <1% P-P | 5 mA |
| J05-5R15 | J05-5R15/Y | 0V to 5Vdc | <100 mA | <250 mA | 0V to 150Vdc | <0.5% P-P | 3.33 mA |
| J05-5R20 | J05-5R20/Y | 0V to 5Vdc | <100 mA | <250 mA | 0V to 200Vdc | <0.25% P-P | 2.5 mA |
| J05-5R25 | J05-5R25/Y | 0V to 5Vdc | <100 mA | <250 mA | 0V to 250Vdc | <0.25% P-P | 2 mA |
| J05-5R30 | J05-5R30/Y | 0V to 5Vdc | <100 mA | <250 mA | 0V to 300Vdc | <0.25% P-P | 1.67 mA |
| J05-5R35 | J05-5R35/Y | 0V to 5Vdc | <100 mA | <250 mA | 0V to 350Vdc | <0.25% P-P | 1.43 mA |
| J05-5R40 | J05-5R40/Y | 0V to 5Vdc | <100 mA | <250 mA | 0V to 400Vdc | <0.1% P-P | 1.25 mA |
| J05-5R45 | J05-5R45/Y | 0V to 5Vdc | <100 mA | <250 mA | 0V to 450Vdc | <0.15% P-P | 1.11 mA |
| J05-5R50 | J05-5R50/Y | 0V to 5Vdc | <100 mA | <250 mA | 0V to 500Vdc | <0.15% P-P | 1 mA |
| J05-5R60 | J05-5R60/Y | 0V to 5Vdc | <100 mA | <250 mA | 0V to 600Vdc | <0.1% P-P | 0.83 mA |
| J05-5R70 | J05-5R70/Y | 0V to 5Vdc | <100 mA | <250 mA | 0V to 700Vdc | <0.25% P-P | 0.72 mA |
| J05-5R80 | J05-5R80/Y | 0V to 5Vdc | <100 mA | <250 mA | 0V to 800Vdc | <0.3% P-P | 0.63 mA |
| J05-5R90 | J05-5R90/Y | 0V to 5Vdc | <100 mA | <250 mA | 0V to 900Vdc | <0.25% P-P | 0.56 mA |
| J05-5P100 | J05-5P100/Y | 0V to 5Vdc | <100 mA | <250 mA | 0V to +1kVdc | <0.25% P-P | 0.5 mA |
| J05-5N100 | J05-5N100/Y | 0V to 5Vdc | <100 mA | <250 mA | 0V to -1kVdc | <0.25% P-P | 0.5 mA |
| J05-5P120 | J05-5P120/Y | 0V to 5Vdc | <100 mA | <250 mA | 0V to +1.2kVdc | <0.25% P-P | 0.42 mA |
| J05-5N120 | J05-5N120/Y | 0V to 5Vdc | <100 mA | <250 mA | 0V to -1.2kVdc | <0.25% P-P | 0.42 mA |
| J05-5P150 | J05-5P150/Y | 0V to 5Vdc | <100 mA | <250 mA | 0V to +1.5kVdc | <0.25% P-P | 0.33 mA |
| J05-5N150 | J05-5N150/Y | 0V to 5Vdc | <100 mA | <250 mA | 0V to -1.5kVdc | <0.25% P-P | 0.33 mA |
| J05-5P200 | J05-5P200/Y | 0V to 5Vdc | <100 mA | <250 mA | 0V to +2kVdc | <0.25% P-P | 0.25 mA |
| J05-5N200 | J05-5N200/Y | 0V to 5Vdc | <100 mA | <250 mA | 0V to -2kVdc | <0.25% P-P | 0.25 mA |

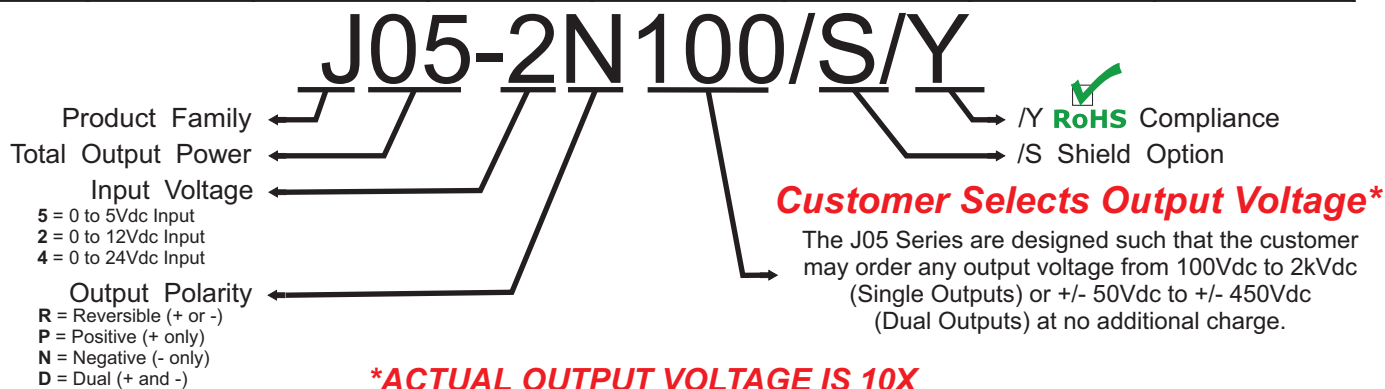



J05 SERIES 0.5 WATT PROPORTIONAL HV DC/DC CONVERTERS

12V INPUT SINGLE OUTPUTS

| REPRESENTATIVE MODEL LISTING | | | | | | | |
|------------------------------|-------------|----------------------|---------|-----------|-----------------------|------------|---------|
| MODEL NUMBER | | INPUT SPECIFICATIONS | | | OUTPUT SPECIFICATIONS | | |
| Non-RoHs | RoHs | VOLTAGE | NO LOAD | FULL LOAD | VOLTAGE | RIPPLE | CURRENT |
| J05-2R10 | J05-2R10/Y | 0V to 12Vdc | <40 mA | <100 mA | 0V to 100Vdc | <1% P-P | 5 mA |
| J05-2R15 | J05-2R15/Y | 0V to 12Vdc | <40 mA | <100 mA | 0V to 150Vdc | <0.5% P-P | 3.33 mA |
| J05-2R20 | J05-2R20/Y | 0V to 12Vdc | <40 mA | <100 mA | 0V to 200Vdc | <0.25% P-P | 2.5 mA |
| J05-2R25 | J05-2R25/Y | 0V to 12Vdc | <40 mA | <100 mA | 0V to 250Vdc | <0.25% P-P | 2 mA |
| J05-2R30 | J05-2R30/Y | 0V to 12Vdc | <40 mA | <100 mA | 0V to 300Vdc | <0.25% P-P | 1.67 mA |
| J05-2R35 | J05-2R35/Y | 0V to 12Vdc | <40 mA | <100 mA | 0V to 350Vdc | <0.25% P-P | 1.43 mA |
| J05-2R40 | J05-2R40/Y | 0V to 12Vdc | <40 mA | <100 mA | 0V to 400Vdc | <0.1% P-P | 1.25 mA |
| J05-2R45 | J05-2R45/Y | 0V to 12Vdc | <40 mA | <100 mA | 0V to 450Vdc | <0.15% P-P | 1.11 mA |
| J05-2R50 | J05-2R50/Y | 0V to 12Vdc | <40 mA | <100 mA | 0V to 500Vdc | <0.15% P-P | 1 mA |
| J05-2R60 | J05-2R60/Y | 0V to 12Vdc | <40 mA | <100 mA | 0V to 600Vdc | <0.1% P-P | 0.83 mA |
| J05-2R70 | J05-2R70/Y | 0V to 12Vdc | <40 mA | <100 mA | 0V to 700Vdc | <0.25% P-P | 0.72 mA |
| J05-2R80 | J05-2R80/Y | 0V to 12Vdc | <40 mA | <100 mA | 0V to 800Vdc | <0.3% P-P | 0.63 mA |
| J05-2R90 | J05-2R90/Y | 0V to 12Vdc | <40 mA | <100 mA | 0V to 900Vdc | <0.25% P-P | 0.56 mA |
| J05-2P100 | J05-2P100/Y | 0V to 12Vdc | <40 mA | <100 mA | 0V to +1kVdc | <0.25% P-P | 0.5 mA |
| J05-2N100 | J05-2N100/Y | 0V to 12Vdc | <40 mA | <100 mA | 0V to -1kVdc | <0.25% P-P | 0.5 mA |
| J05-2P120 | J05-2P120/Y | 0V to 12Vdc | <40 mA | <100 mA | 0V to +1.2kVdc | <0.25% P-P | 0.42 mA |
| J05-2N120 | J05-2N120/Y | 0V to 12Vdc | <40 mA | <100 mA | 0V to -1.2kVdc | <0.25% P-P | 0.42 mA |
| J05-2P150 | J05-2P150/Y | 0V to 12Vdc | <40 mA | <100 mA | 0V to +1.5kVdc | <0.25% P-P | 0.33 mA |
| J05-2N150 | J05-2N150/Y | 0V to 12Vdc | <40 mA | <100 mA | 0V to -1.5kVdc | <0.25% P-P | 0.33 mA |
| J05-2P200 | J05-2P200/Y | 0V to 12Vdc | <40 mA | <100 mA | 0V to +2kVdc | <0.25% P-P | 0.25 mA |
| J05-2N200 | J05-2N200/Y | 0V to 12Vdc | <40 mA | <100 mA | 0V to -2kVdc | <0.25% P-P | 0.25 mA |



J05 SERIES 0.5 WATT PROPORTIONAL HV DC/DC CONVERTERS

24V INPUT SINGLE OUTPUTS

| REPRESENTATIVE MODEL LISTING | | | | | | | |
|------------------------------|-------------|----------------------|---------|-----------|-----------------------|------------|---------|
| MODEL NUMBER | | INPUT SPECIFICATIONS | | | OUTPUT SPECIFICATIONS | | |
| Non-RoHs | RoHs | VOLTAGE | NO LOAD | FULL LOAD | VOLTAGE | RIPPLE | CURRENT |
| J05-4R10 | J05-4R10/Y | 0V to 24Vdc | <20 mA | <50 mA | 0V to 100Vdc | <1% P-P | 5 mA |
| J05-4R15 | J05-4R15/Y | 0V to 24Vdc | <20 mA | <50 mA | 0V to 150Vdc | <0.5% P-P | 3.33 mA |
| J05-4R20 | J05-4R20/Y | 0V to 24Vdc | <20 mA | <50 mA | 0V to 200Vdc | <0.25% P-P | 2.5 mA |
| J05-4R25 | J05-4R25/Y | 0V to 24Vdc | <20 mA | <50 mA | 0V to 250Vdc | <0.25% P-P | 2 mA |
| J05-4R30 | J05-4R30/Y | 0V to 24Vdc | <20 mA | <50 mA | 0V to 300Vdc | <0.25% P-P | 1.67 mA |
| J05-4R35 | J05-4R35/Y | 0V to 24Vdc | <20 mA | <50 mA | 0V to 350Vdc | <0.25% P-P | 1.43 mA |
| J05-4R40 | J05-4R40/Y | 0V to 24Vdc | <20 mA | <50 mA | 0V to 400Vdc | <0.1% P-P | 1.25 mA |
| J05-4R45 | J05-4R45/Y | 0V to 24Vdc | <20 mA | <50 mA | 0V to 450Vdc | <0.15% P-P | 1.11 mA |
| J05-4R50 | J05-4R50/Y | 0V to 24Vdc | <20 mA | <50 mA | 0V to 500Vdc | <0.15% P-P | 1 mA |
| J05-4R60 | J05-4R60/Y | 0V to 24Vdc | <20 mA | <50 mA | 0V to 600Vdc | <0.1% P-P | 0.83 mA |
| J05-4R70 | J05-4R70/Y | 0V to 24Vdc | <20 mA | <50 mA | 0V to 700Vdc | <0.25% P-P | 0.72 mA |
| J05-4R80 | J05-4R80/Y | 0V to 24Vdc | <20 mA | <50 mA | 0V to 800Vdc | <0.3% P-P | 0.63 mA |
| J05-4R90 | J05-4R90/Y | 0V to 24Vdc | <20 mA | <50 mA | 0V to 900Vdc | <0.25% P-P | 0.56 mA |
| J05-4P100 | J05-4P100/Y | 0V to 24Vdc | <20 mA | <50 mA | 0V to +1kVdc | <0.25% P-P | 0.5 mA |
| J05-4N100 | J05-4N100/Y | 0V to 24Vdc | <20 mA | <50 mA | 0V to -1kVdc | <0.25% P-P | 0.5 mA |
| J05-4P120 | J05-4P120/Y | 0V to 24Vdc | <20 mA | <50 mA | 0V to +1.2kVdc | <0.25% P-P | 0.42 mA |
| J05-4N120 | J05-4N120/Y | 0V to 24Vdc | <20 mA | <50 mA | 0V to -1.2kVdc | <0.25% P-P | 0.42 mA |
| J05-4P150 | J05-4P150/Y | 0V to 24Vdc | <20 mA | <50 mA | 0V to +1.5kVdc | <0.25% P-P | 0.33 mA |
| J05-4N150 | J05-4N150/Y | 0V to 24Vdc | <20 mA | <50 mA | 0V to -1.5kVdc | <0.25% P-P | 0.33 mA |
| J05-4P200 | J05-4P200/Y | 0V to 24Vdc | <20 mA | <50 mA | 0V to +2kVdc | <0.25% P-P | 0.25 mA |
| J05-4N200 | J05-4N200/Y | 0V to 24Vdc | <20 mA | <50 mA | 0V to -2kVdc | <0.25% P-P | 0.25 mA |



J05 SERIES 0.5 WATT PROPORTIONAL HV DC/DC CONVERTERS

DUAL OUTPUTS

| REPRESENTATIVE MODEL LISTING | | | | | | | |
|------------------------------|------------|----------------------|---------|-----------|-----------------------|------------|---------|
| MODEL NUMBER | | INPUT SPECIFICATIONS | | | OUTPUT SPECIFICATIONS | | |
| Non-RoHs | RoHs | VOLTAGE | NO LOAD | FULL LOAD | VOLTAGE | RIPPLE | CURRENT |
| J05-5D5 | J05-5D5/Y | 0V to 5Vdc | <100 mA | <250 mA | 0V to +/-50Vdc | <1% P-P | 5 mA |
| J05-2D5 | J05-2D5/Y | 0V to 12Vdc | <40 mA | <100 mA | 0V to +/-50Vdc | <1% P-P | 5 mA |
| J05-4D5 | J05-4D5/Y | 0V to 24Vdc | <20 mA | <50 mA | 0V to +/-50Vdc | <1% P-P | 5 mA |
| J05-5D10 | J05-5D10/Y | 0V to 5Vdc | <100 mA | <250 mA | 0V to +/-100Vdc | <0.25% P-P | 2.5 mA |
| J05-2D10 | J05-2D10/Y | 0V to 12Vdc | <40 mA | <100 mA | 0V to +/-100Vdc | <0.25% P-P | 2.5 mA |
| J05-4D10 | J05-4D10/Y | 0V to 24Vdc | <20 mA | <50 mA | 0V to +/-100Vdc | <0.25% P-P | 2.5 mA |
| J05-5D15 | J05-5D15/Y | 0V to 5Vdc | <100 mA | <250 mA | 0V to +/-150Vdc | <0.25% P-P | 1.67 mA |
| J05-2D15 | J05-2D15/Y | 0V to 12Vdc | <40 mA | <100 mA | 0V to +/-150Vdc | <0.25% P-P | 1.67 mA |
| J05-4D15 | J05-4D15/Y | 0V to 24Vdc | <20 mA | <50 mA | 0V to +/-150Vdc | <0.25% P-P | 1.67 mA |
| J05-5D20 | J05-5D20/Y | 0V to 5Vdc | <100 mA | <250 mA | 0V to +/-200Vdc | <0.1% P-P | 1.25 mA |
| J05-2D20 | J05-2D20/Y | 0V to 12Vdc | <40 mA | <100 mA | 0V to +/-200Vdc | <0.1% P-P | 1.25 mA |
| J05-4D20 | J05-4D20/Y | 0V to 24Vdc | <20 mA | <50 mA | 0V to +/-200Vdc | <0.1% P-P | 1.25 mA |
| J05-5D25 | J05-5D25/Y | 0V to 5Vdc | <100 mA | <250 mA | 0V to +/-250Vdc | <0.15% P-P | 1 mA |
| J05-2D25 | J05-2D25/Y | 0V to 12Vdc | <40 mA | <100 mA | 0V to +/-250Vdc | <0.15% P-P | 1 mA |
| J05-4D25 | J05-4D25/Y | 0V to 24Vdc | <20 mA | <50 mA | 0V to +/-250Vdc | <0.15% P-P | 1 mA |
| J05-5D30 | J05-5D30/Y | 0V to 5Vdc | <100 mA | <250 mA | 0V to +/-300Vdc | <0.1% P-P | 0.83 mA |
| J05-2D30 | J05-2D30/Y | 0V to 12Vdc | <40 mA | <100 mA | 0V to +/-300Vdc | <0.1% P-P | 0.83 mA |
| J05-4D30 | J05-4D30/Y | 0V to 24Vdc | <20 mA | <50 mA | 0V to +/-300Vdc | <0.1% P-P | 0.83 mA |
| J05-5D35 | J05-5D35/Y | 0V to 5Vdc | <100 mA | <250 mA | 0V to +/-350Vdc | <0.25% P-P | 0.72 mA |
| J05-2D35 | J05-2D35/Y | 0V to 12Vdc | <40 mA | <100 mA | 0V to +/-350Vdc | <0.25% P-P | 0.72 mA |
| J05-4D35 | J05-4D35/Y | 0V to 24Vdc | <20 mA | <50 mA | 0V to +/-350Vdc | <0.25% P-P | 0.72 mA |
| J05-5D40 | J05-5D40/Y | 0V to 5Vdc | <100 mA | <250 mA | 0V to +/-400Vdc | <0.3% P-P | 0.63 mA |
| J05-2D40 | J05-2D40/Y | 0V to 12Vdc | <40 mA | <100 mA | 0V to +/-400Vdc | <0.3% P-P | 0.63 mA |
| J05-4D40 | J05-4D40/Y | 0V to 24Vdc | <20 mA | <50 mA | 0V to +/-400Vdc | <0.3% P-P | 0.63 mA |
| J05-5D45 | J05-5D45/Y | 0V to 5Vdc | <100 mA | <250 mA | 0V to +/-450Vdc | <0.25% P-P | 0.56 mA |
| J05-2D45 | J05-2D45/Y | 0V to 12Vdc | <40 mA | <100 mA | 0V to +/-450Vdc | <0.25% P-P | 0.56 mA |
| J05-4D45 | J05-4D45/Y | 0V to 24Vdc | <20 mA | <50 mA | 0V to +/-450Vdc | <0.25% P-P | 0.56 mA |

NOTE: Ripple on dual output units are measured between the positive and negative output pins.



J05 SERIES 0.5 WATT PROPORTIONAL HV DC/DC CONVERTERS

STANDARD

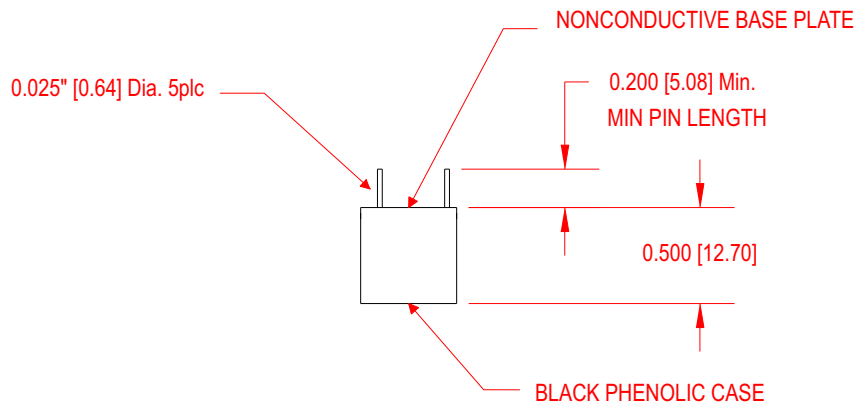
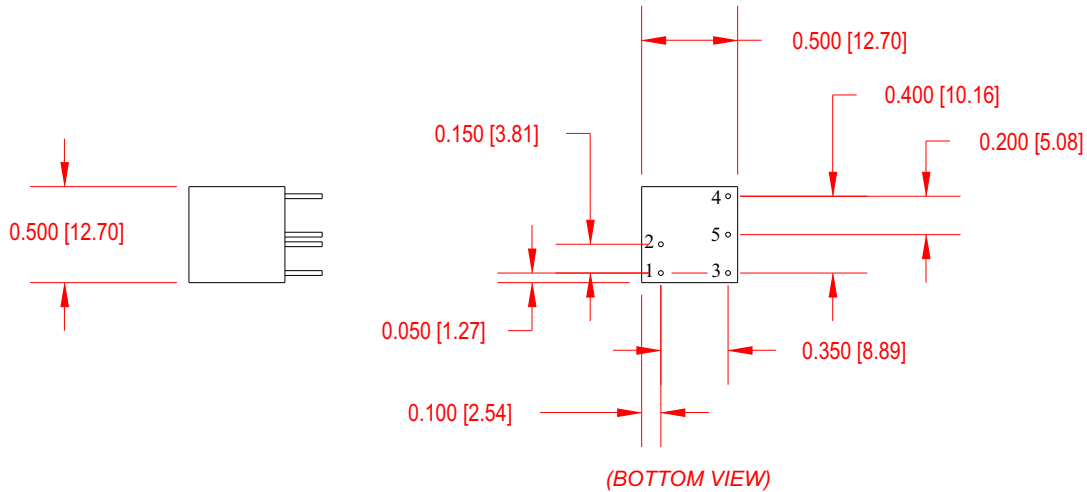

| PIN # | 100V TO 900V OUTPUTS | DUAL OUTPUTS | POSITIVE 1KV TO 2KV OUTPUTS | NEGATIVE 1KV TO 2KV OUTPUTS |
|-------|----------------------|--------------|-----------------------------|-----------------------------|
| 1 | - INPUT | - INPUT | - INPUT | - INPUT |
| 2 | + INPUT | + INPUT | + INPUT | + INPUT |
| 3 | + OUTPUT | + OUTPUT | + OUTPUT | - OUTPUT |
| 4 | - OUTPUT | - OUTPUT | HV RTN | HV RTN |
| 5 | NO PIN | COM | NO PIN | NO PIN |

*Dimensions are in Inches
 [Metric equivalents in brackets]*



J05 SERIES 0.5 WATT PROPORTIONAL HV DC/DC CONVERTERS

SHIELD OPTION (/S)

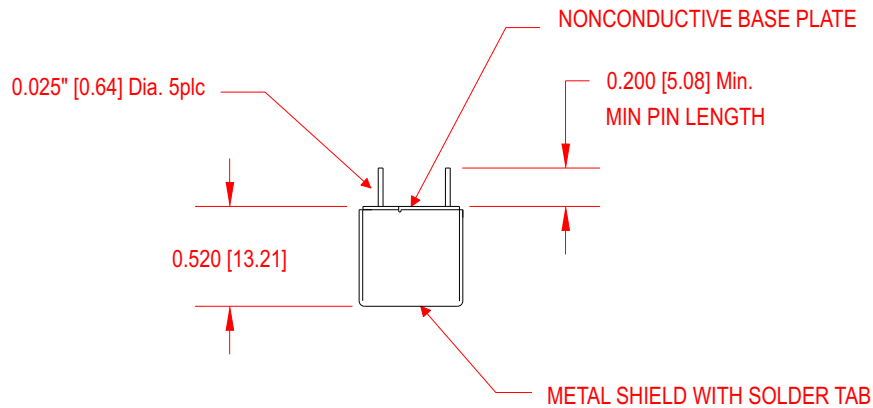
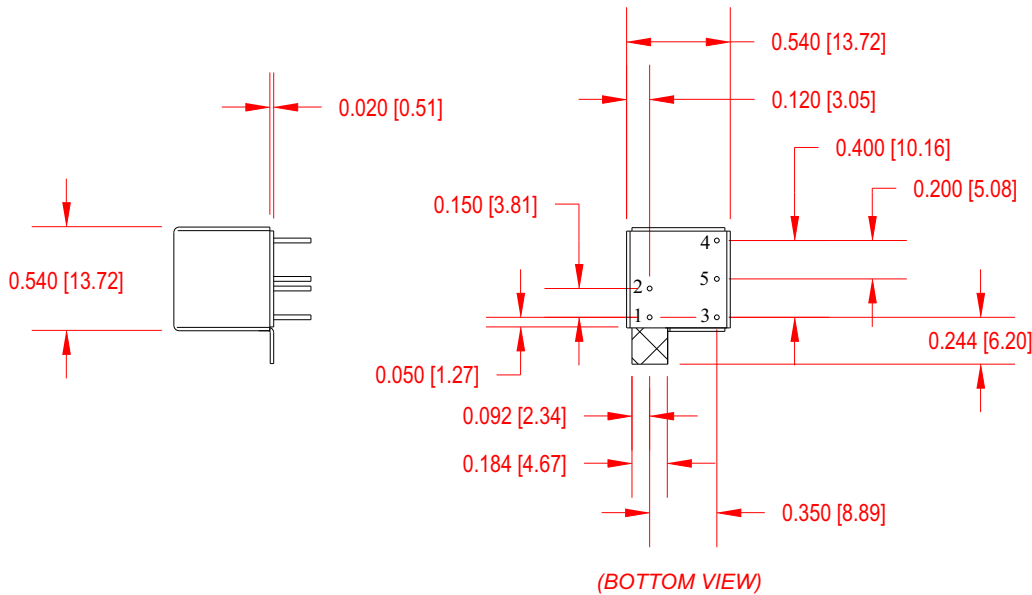

| PIN # | 100V TO 900V OUTPUTS | DUAL OUTPUTS | POSITIVE 1KV TO 2KV OUTPUTS | NEGATIVE 1KV TO 2KV OUTPUTS |
|-------|----------------------|--------------|-----------------------------|-----------------------------|
| 1 | - INPUT | - INPUT | - INPUT | - INPUT |
| 2 | + INPUT | + INPUT | + INPUT | + INPUT |
| 3 | + OUTPUT | + OUTPUT | + OUTPUT | - OUTPUT |
| 4 | - OUTPUT | - OUTPUT | HV RTN | HV RTN |
| 5 | NO PIN | COM | NO PIN | NO PIN |

*Dimensions are in Inches
[Metric equivalents in brackets]*



J05 SERIES 0.5 WATT PROPORTIONAL HV DC/DC CONVERTERS

APPLICATION NOTES

INPUT AND OUTPUT IMPEDANCE

The J05 Series of power converters have been designed to be stable with no external capacitors when used in low inductance input and output circuits. However, in some applications, the inductance associated with the distribution from the power source to the input of the converter can affect the stability of the converter. The addition of a 10 μ F electrolytic capacitor with an ESR <1 Ohm across the input helps ensure stability of the converter. In some applications, the user may need to use decoupling capacitance at the load.

SHORT CIRCUIT PROTECTION

The J05 Series is equipped with short circuit protection. The converter will fold-back the input power whenever a short circuit is applied to its output and automatically recover after the overload condition is removed.

ISOLATION

The output of the J05 Series is galvanically isolated from the input, capacitance is < 30pF and resistance is > 10G Ohm. For dual output units Isolation is from Com output pin (5) and -Input (1).

RIPPLE AND NOISE

Figure below shows a typical output voltage ripple waveform, measured at full rated load current with no additional output filtering. External low ESR capacitors may be added across output to further reduce ripple.

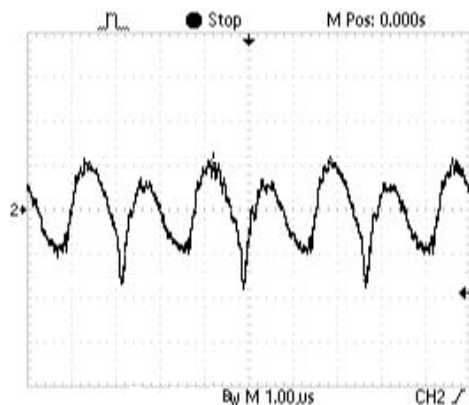

STARTUP TRANSIENT

Figure below shows a typical output voltage during turn-on, measured at no load current with no additional output filtering.

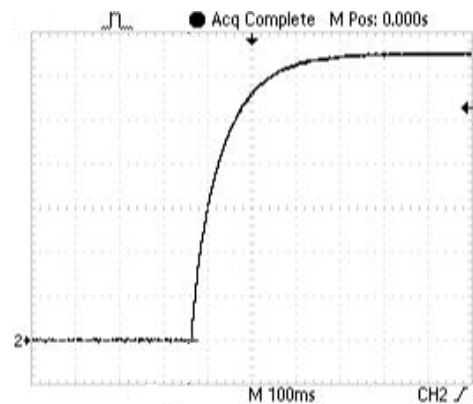
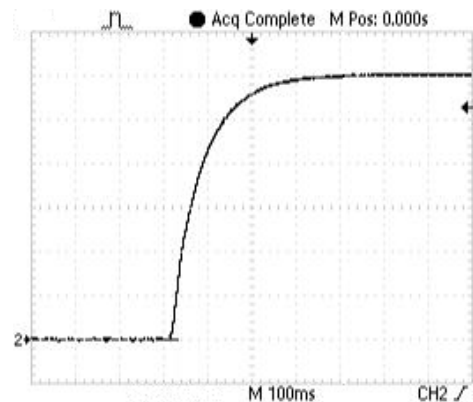

Figure below shows a typical output voltage during turn-on, measured at full rated load current with no additional output filtering.





J05 SERIES 0.5 WATT PROPORTIONAL HV DC/DC CONVERTERS

APPLICATION NOTES

INRUSH CURRENT

The inrush current of the J05 Series has been kept as low as possible. However, a series resistor may be inserted in the input line to limit this current further.

LOAD TRANSIENT

Figure below shows a typical output voltage response, measured during a transition from full rated load current to no load current with no additional output filtering.

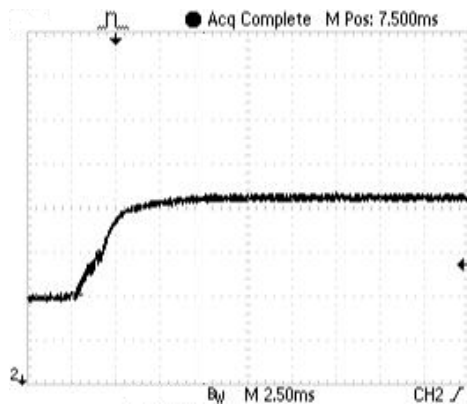
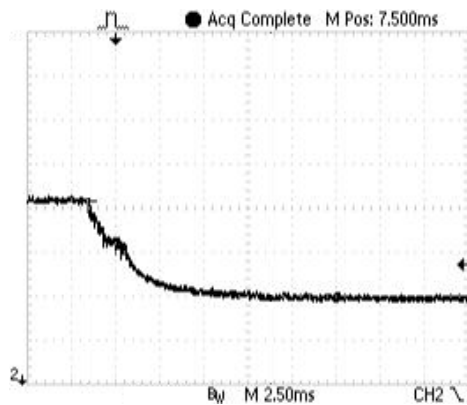

Figure below shows a typical output voltage response, measured during a transition from no load current to full rated load current with no additional output filtering.



CONNECTION IN PARALLEL

The figures below shows how to connect outputs of several units with equal nominal output voltage in parallel with the use of oring diodes.

POSITIVE OUTPUT

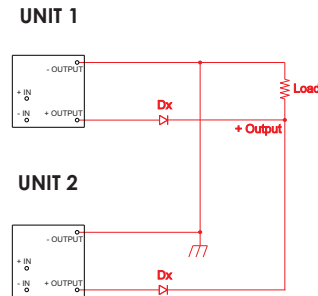

NEGATIVE OUTPUT (100V TO 900V)

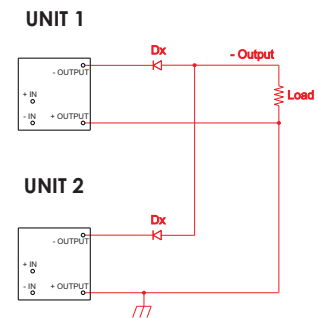

NEGATIVE OUTPUT (1KV TO 2KV)

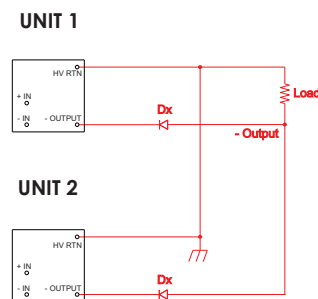

NOTE:
The ratings of Dx should be 1.5 times the maximum current and voltage expected in each branch.



J05 SERIES 0.5 WATT PROPORTIONAL HV DC/DC CONVERTERS

CONNECTION IN SERIES

Figures below shows how to connect multiple outputs in series with the use of shunt diodes, taking into consideration that the highest achieved output voltage should remain below the rated isolation voltage (500V).

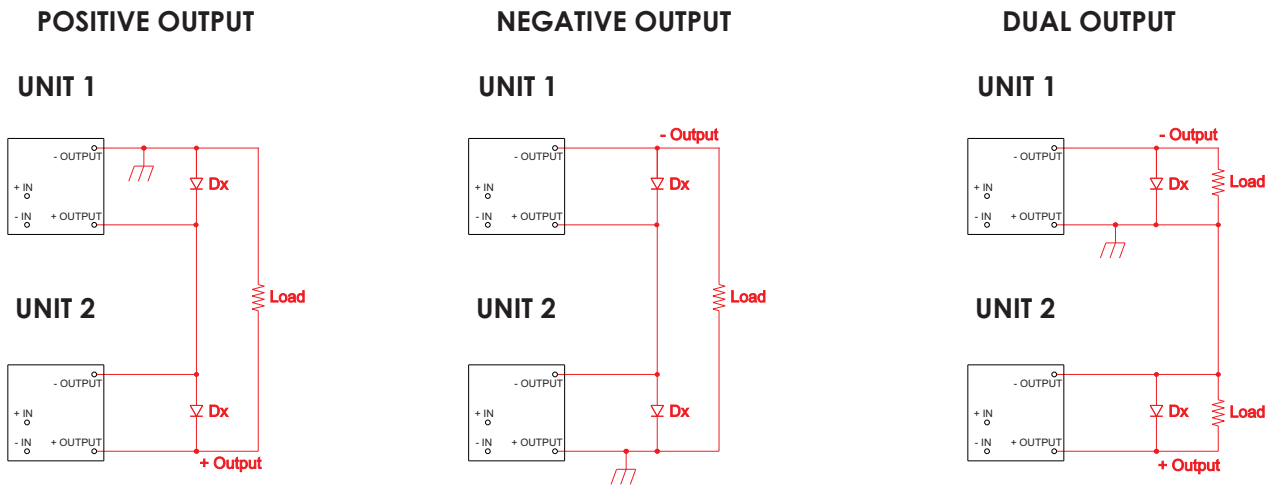

NOTE:

The ratings of Dx should be 1.5 times the maximum current and voltage expected in each branch.



J05 SERIES 0.5 WATT PROPORTIONAL HV DC/DC CONVERTERS

APPLICATION NOTES

POSITIVE OR NEGATIVE OUTPUTS

Isolated DC-DC voltage converters can provide positive or negative voltages from a single device.

Isolated DC-DC converters may also be used with either a positive or a negative input voltage source, as long as the relative polarity of the input to the device is maintained.

The figures below show the various polarity combinations and how to connect the converter to provide them relative to ground.

POSITIVE SOURCE WITH A POSITIVE OUTPUT

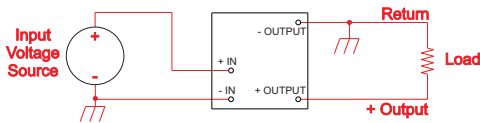

POSITIVE SOURCE WITH A NEGATIVE OUTPUT (100V TO 900V)

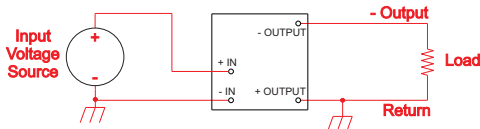

NEGATIVE SOURCE WITH A POSITIVE OUTPUT

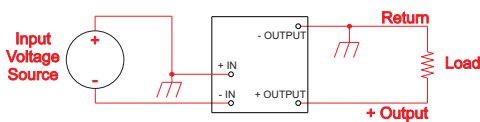

NEGATIVE SOURCE WITH A NEGATIVE OUTPUT (100V TO 900V)

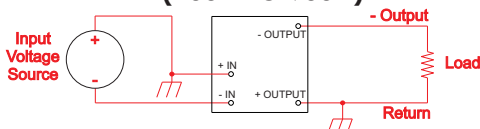

POSITIVE SOURCE WITH A NEGATIVE OUTPUT (-1KV TO -2KV)

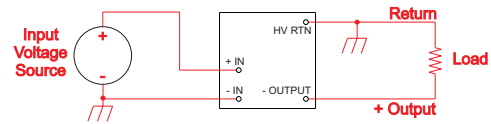

NEGATIVE SOURCE WITH A NEGATIVE OUTPUT (-1KV TO -2KV)

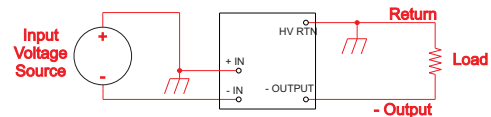

CONNECTIONS FOR DUAL OUTPUTS

Isolation on a dual output converter is from Com output pin (5) and therefore ground connection on the output is to Com pin only.

The figures below shows how to power a dual output converter with either a positive or a negative input voltage source.

POSITIVE VOLTAGE SOURCE

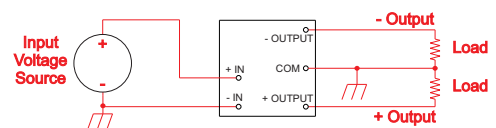

NEGATIVE VOLTAGE SOURCE

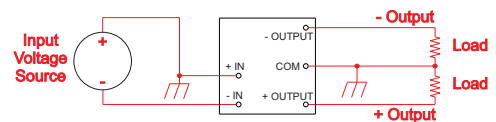

NOTE:
The (- In) must be kept negative with respect to the (+In) pin. If this polarity is reversed, permanent damage to the converter may occur.



J05 SERIES 0.5 WATT PROPORTIONAL HV DC/DC CONVERTERS

APPLICATION NOTES

CLEANING AGENTS

In order to avoid possible damage, any penetration of cleaning fluids must be prevented, since the power supplies are not hermetically sealed.

NUCLEAR AND MEDICAL APPLICATIONS

American Power Design products are not designed, intended for use in, or authorized for use as critical components in life support systems, equipment used in hazardous environments, or nuclear control systems without the express written consent of American Power Design, Inc.

TECHNICAL REVISIONS

The appearance of products, including safety agency certifications pictured on labels, may change depending on the date manufactured. Specifications are subject to change without notice.

SAFETY REQUIREMENTS

The converters are designed to meet North American and International safety regulatory requirements per UL 60950-1/CSA 22.2 No. 60950-1-07 Second Edition, IEC 60950-1:2005, and EN 60950-1:2006. Basic Insulation is provided between input and output. To comply with safety agencies requirements, an input line fuse must be used external to the converter. The table below provides the recommended fuse rating for use with this family of products.

| Input Voltage Range | Fuse Rating |
|---------------------|-------------|
| 0 to 5Vdc | 1A |
| 0 to 12Vdc | 0.5A |
| 0 to 24Vdc | 0.2A |

If one input fuse is used for a group of modules, the maximum fuse rating should not exceed 5A.

WARRANTY

All products manufactured by American Power Design, Inc. (APD) are warranted to be free of defects due to material or workmanship for a period of one year from date of shipment. At our option, APD will repair or replace any non-conforming product.

APD expressly disclaims any liability for consequential or incidental damages resulting from the use or misuse of its products by the purchaser or others.

This warranty is in lieu of all warranties expressed or implied, including the warranties of merchantability. No other warranties, obligations, or liabilities are expressed or implied.

All products being returned for repair require a return material authorization(RMA) assigned by APD prior to return shipment.